

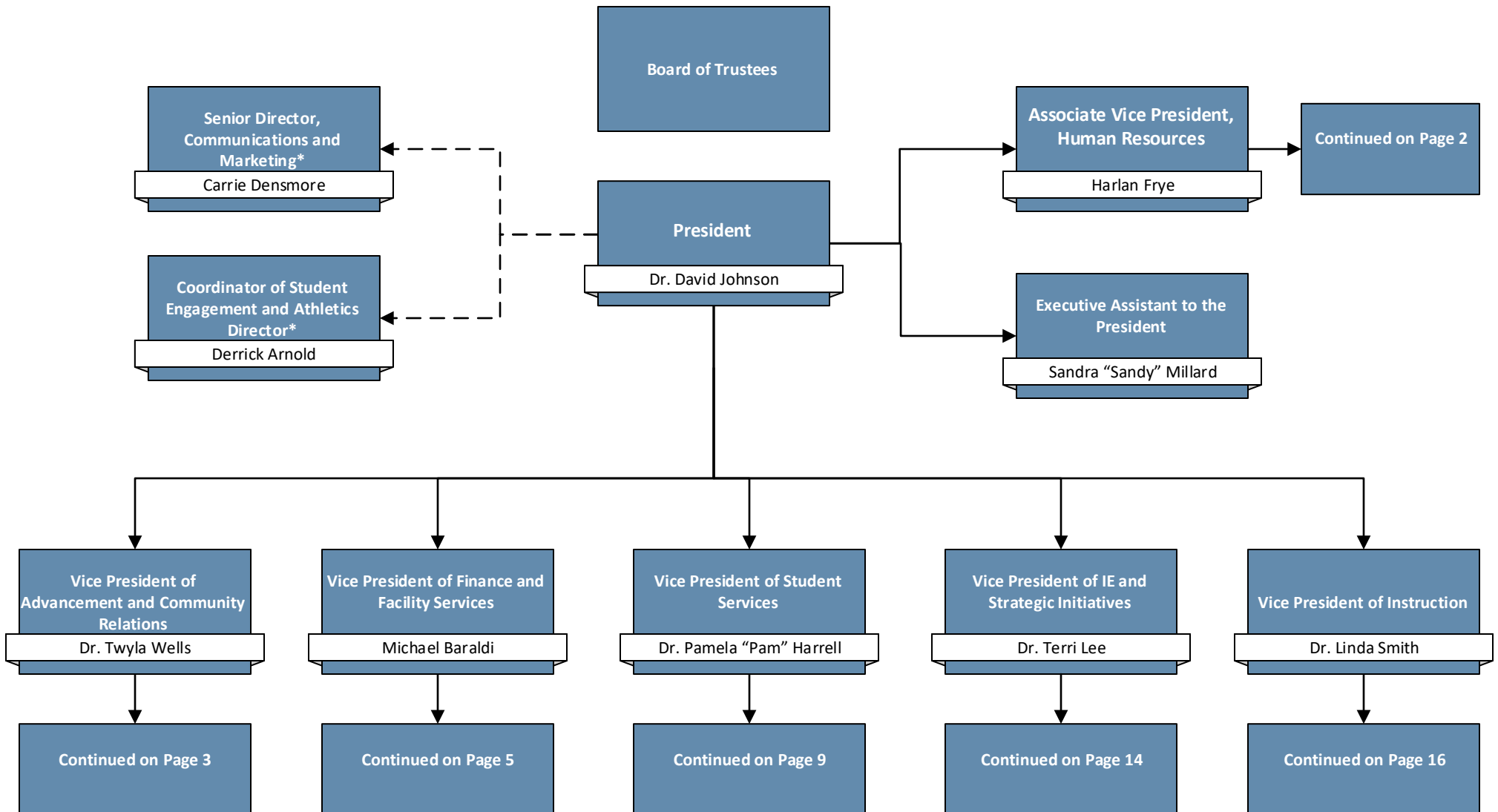

# Organizational Structure

## President's Office and Vice Presidents





# Organizational Structure

## Human Resources, Safety and Campus Security

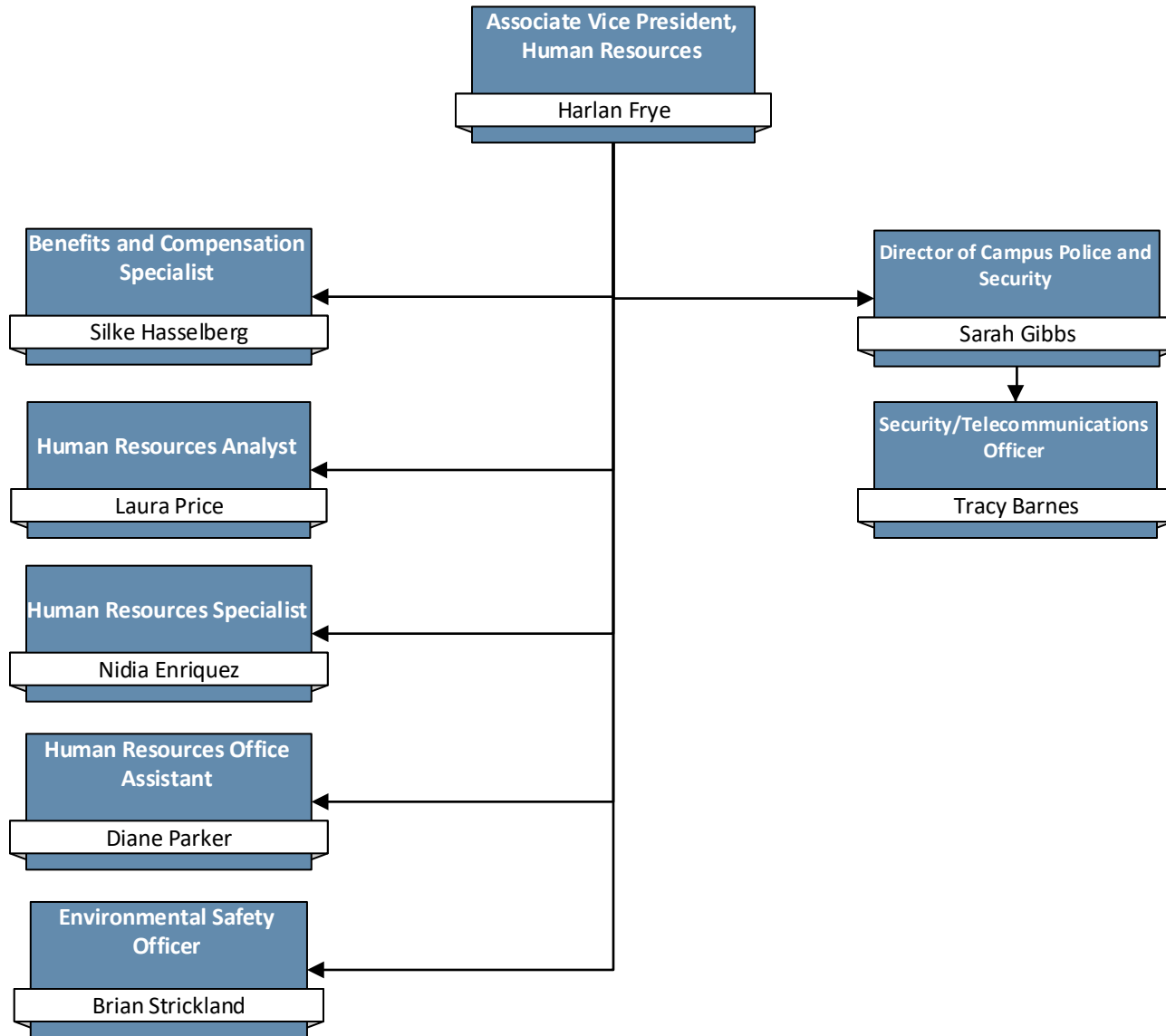



# Organizational Structure

## Advancement and Community Relations

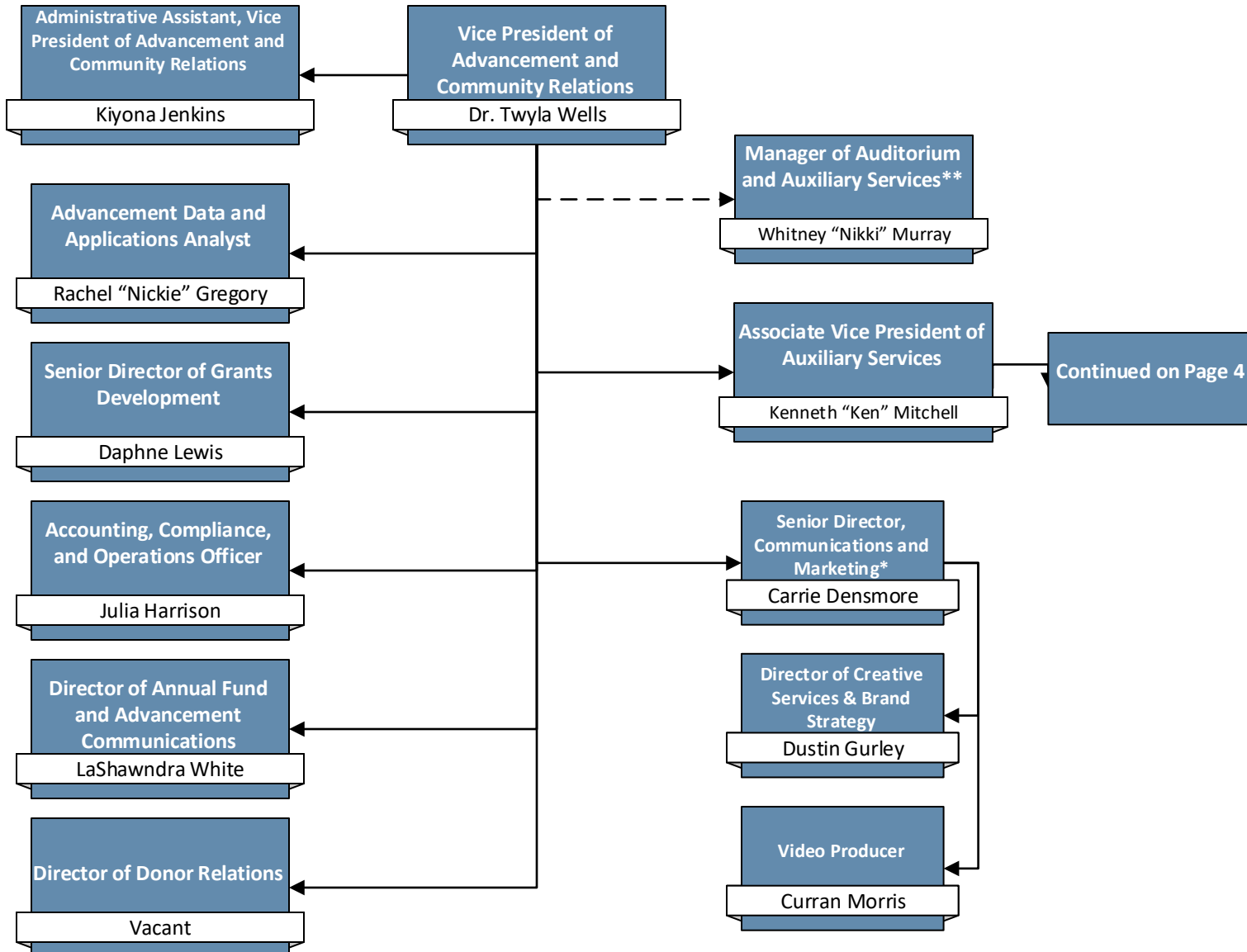

\*While this position reports directly to the vice president of advancement and community relations, it also maintains a direct advisory relationship with the president.



# Organizational Structure

## Auxiliary Services

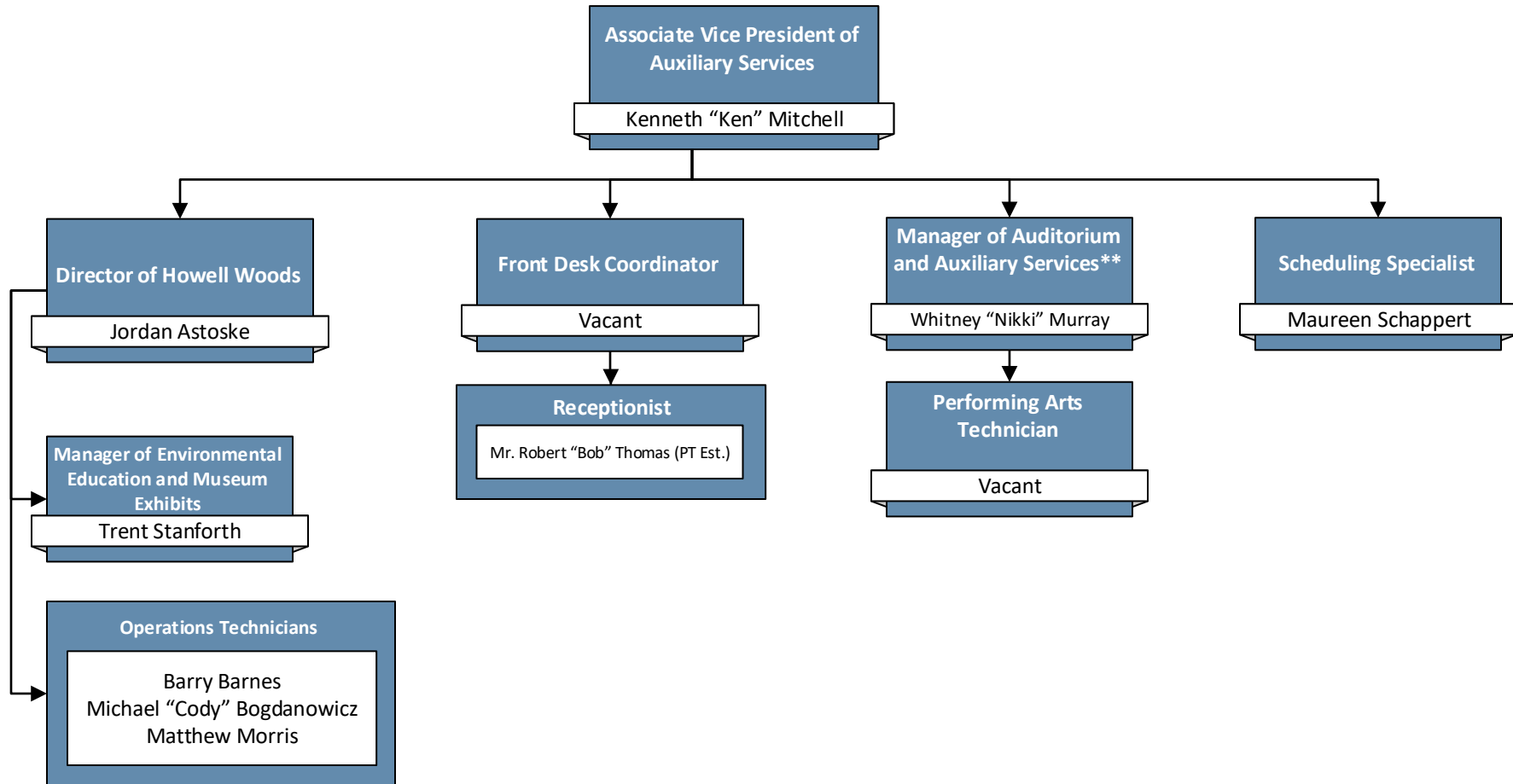

\*\*While this position reports directly to the associate vice president of auxiliary services, it also maintains a direct advisory relationship with the vice president of advancement and community relations



# Organizational Structure

## Finance and Facility Services

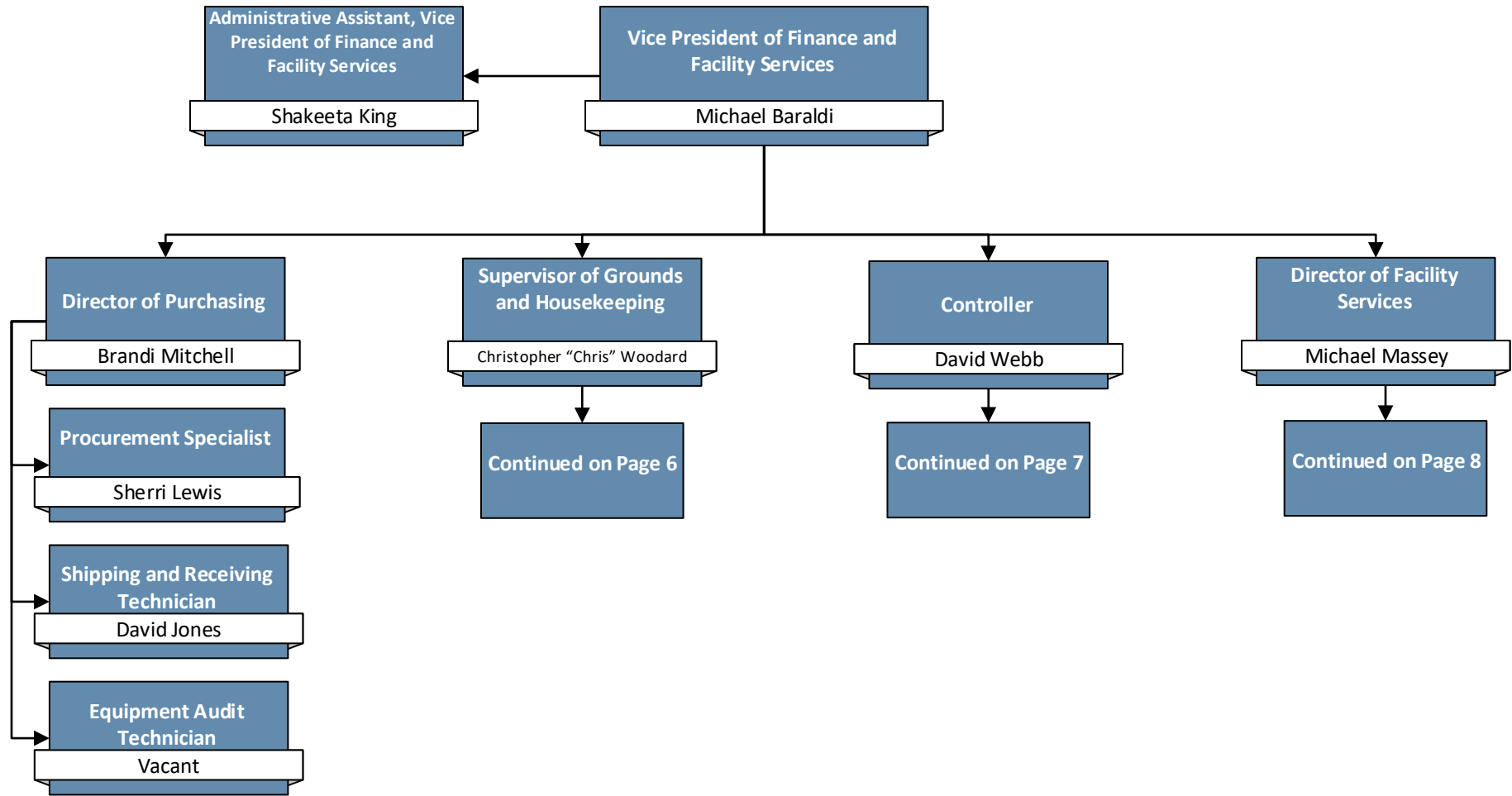



# Organizational Structure

## Grounds and Housekeeping

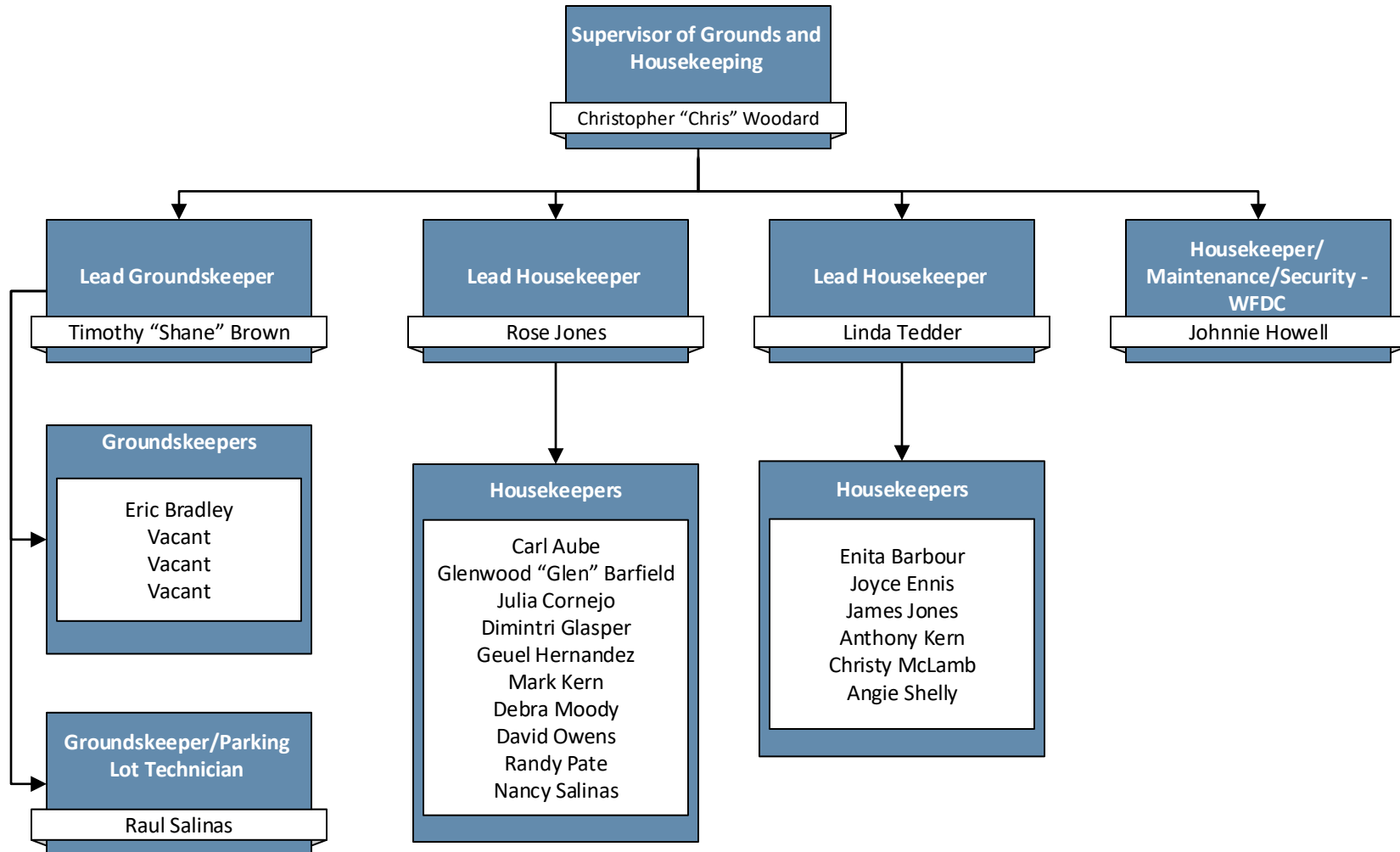



# Organizational Structure

## Controller

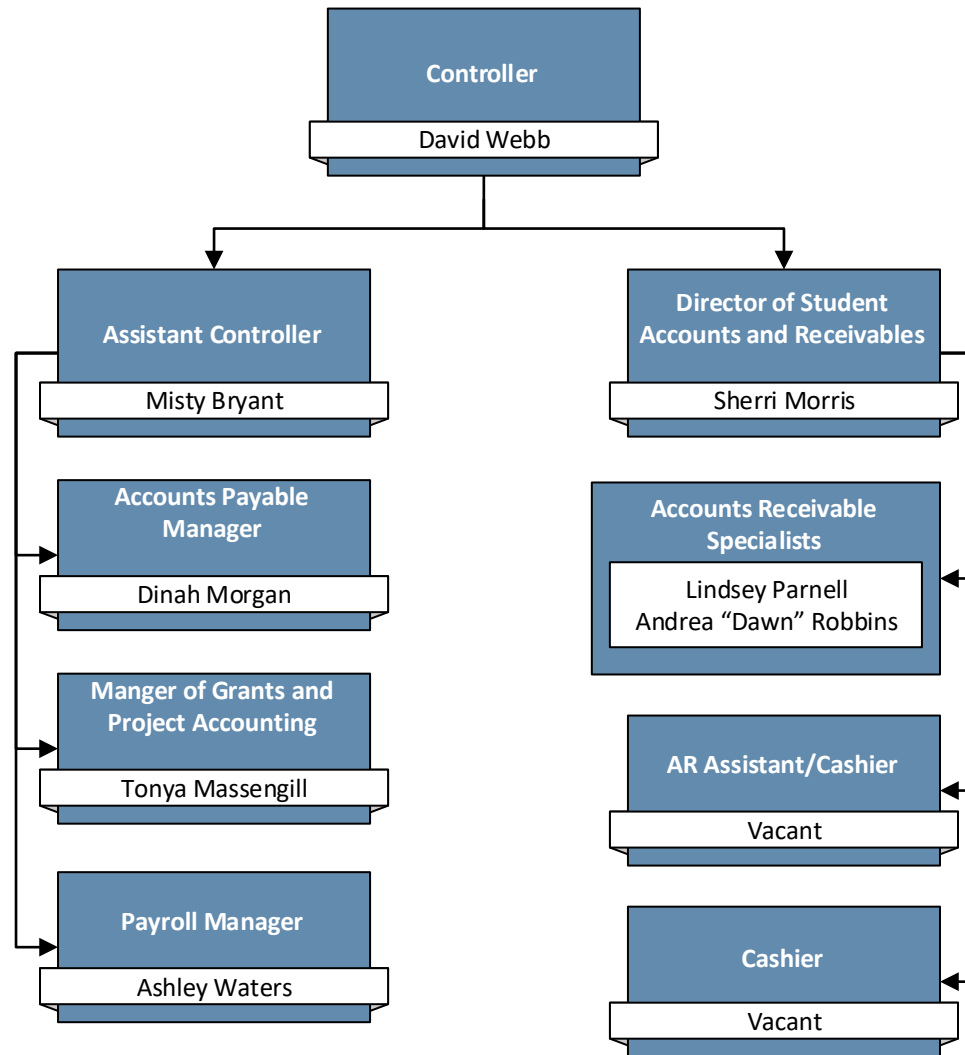



# Organizational Structure

## Facility Services

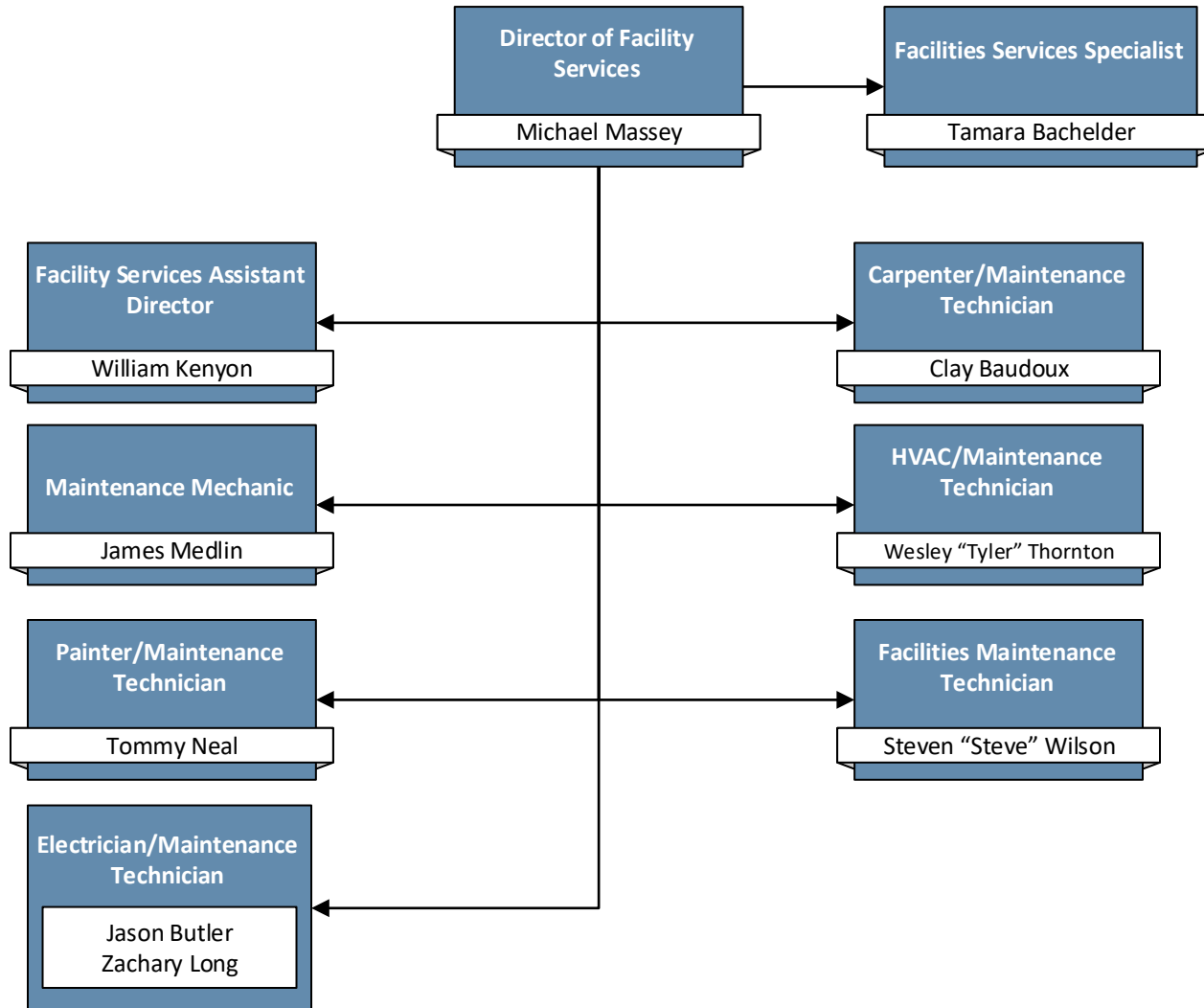





# Organizational Structure

## Student Services

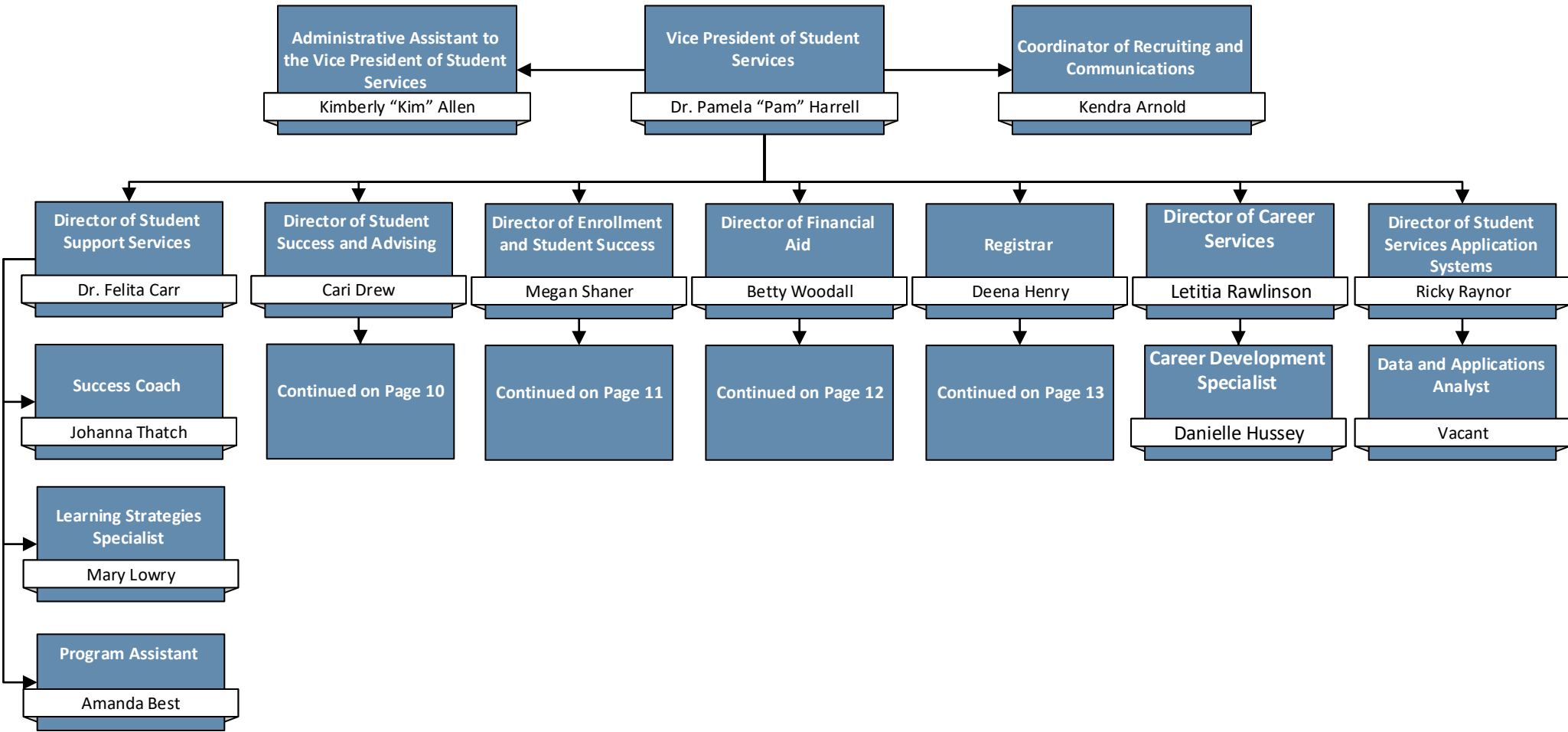



# Organizational Structure

## Student Success & Advising

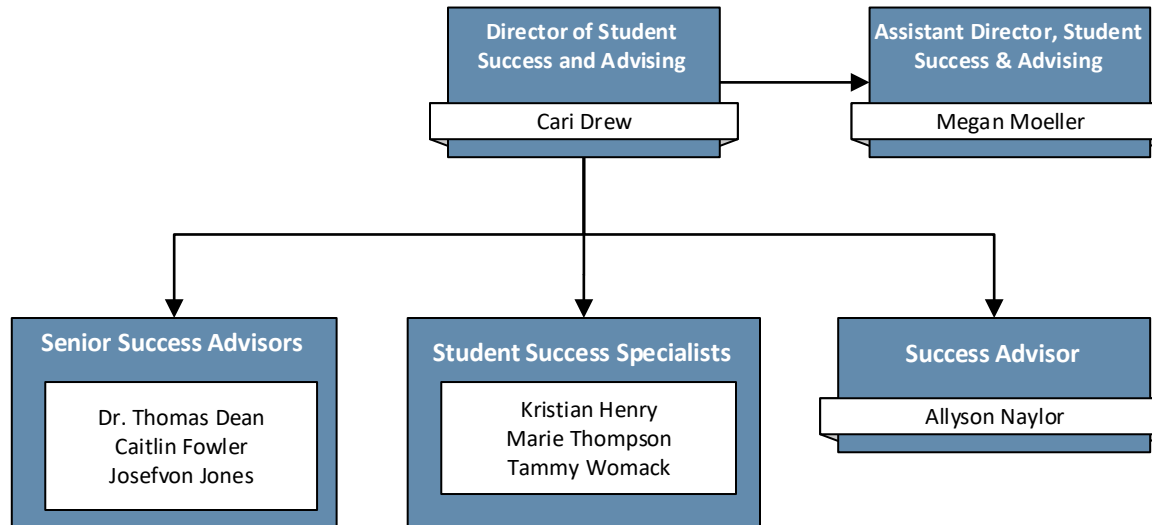



# Organizational Structure

## Admissions and Student Engagement

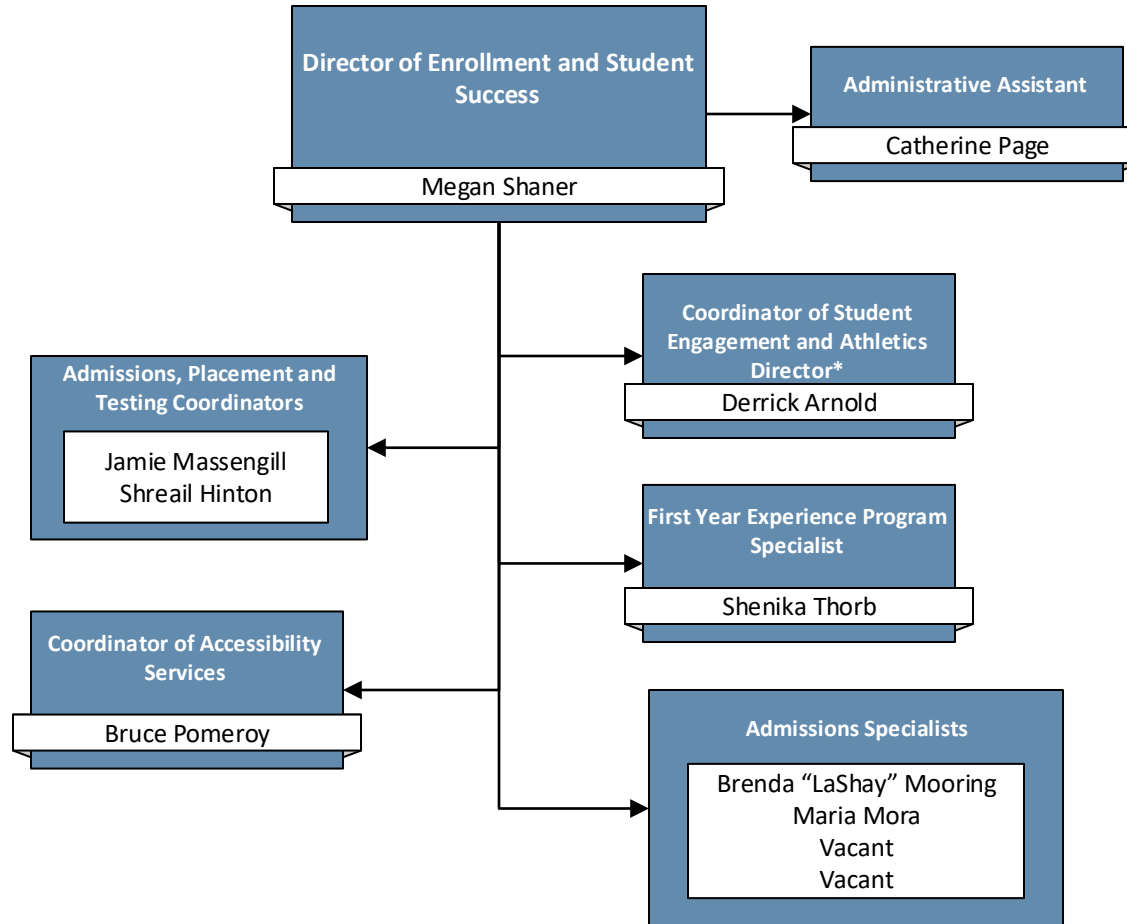

\*While this position reports directly to the director of enrollment and student success, it also maintains a direct advisory relationship with the president.



# Organizational Structure

## Financial Aid

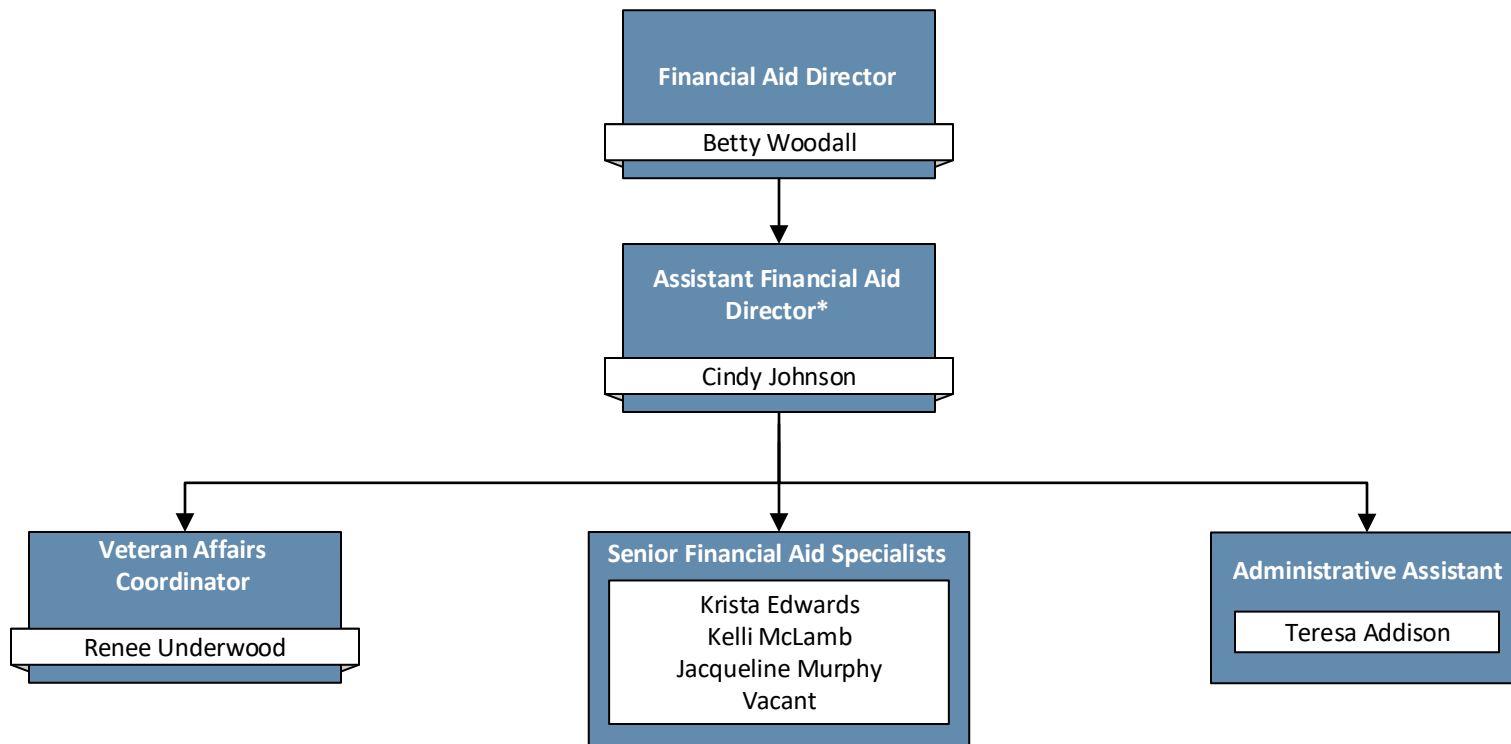



# Organizational Structure

## Registrar

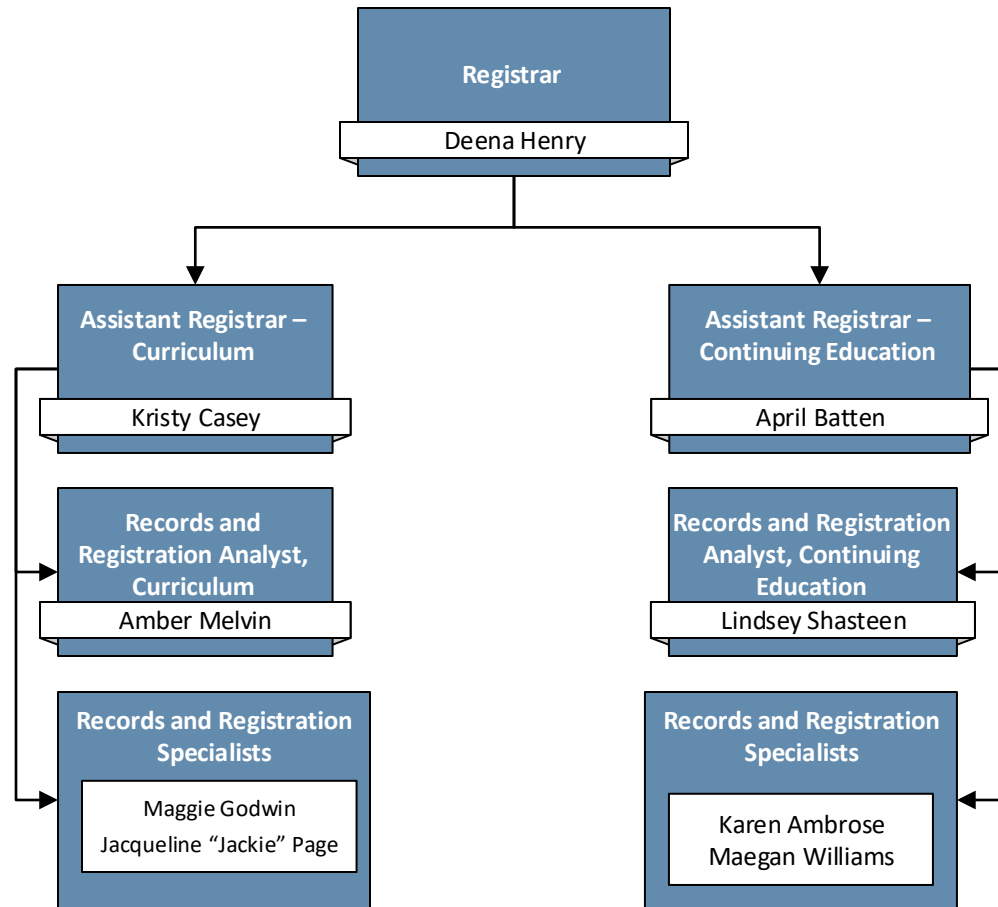



# Organizational Structure

## Institutional Effectiveness and Strategic Initiatives

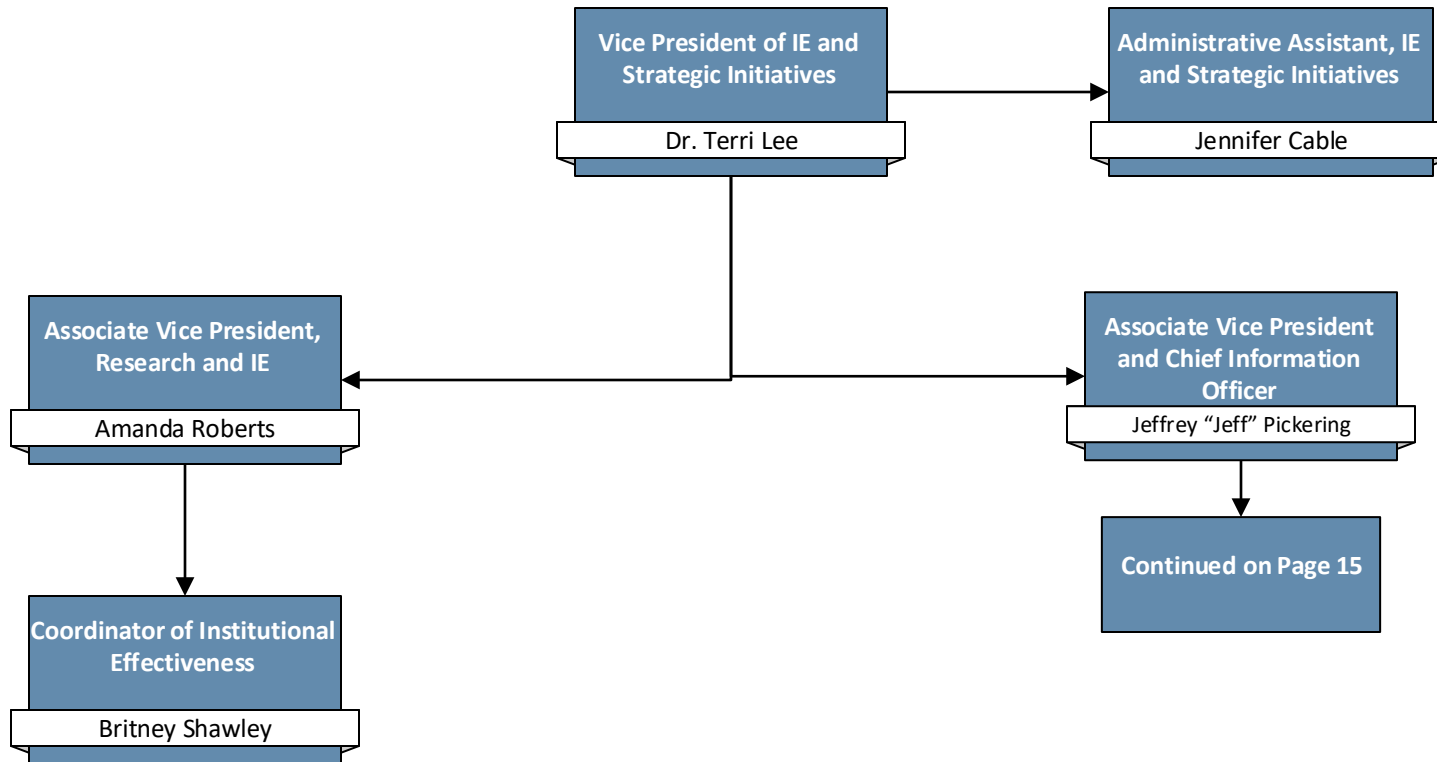



# Organizational Structure

## Information Technology

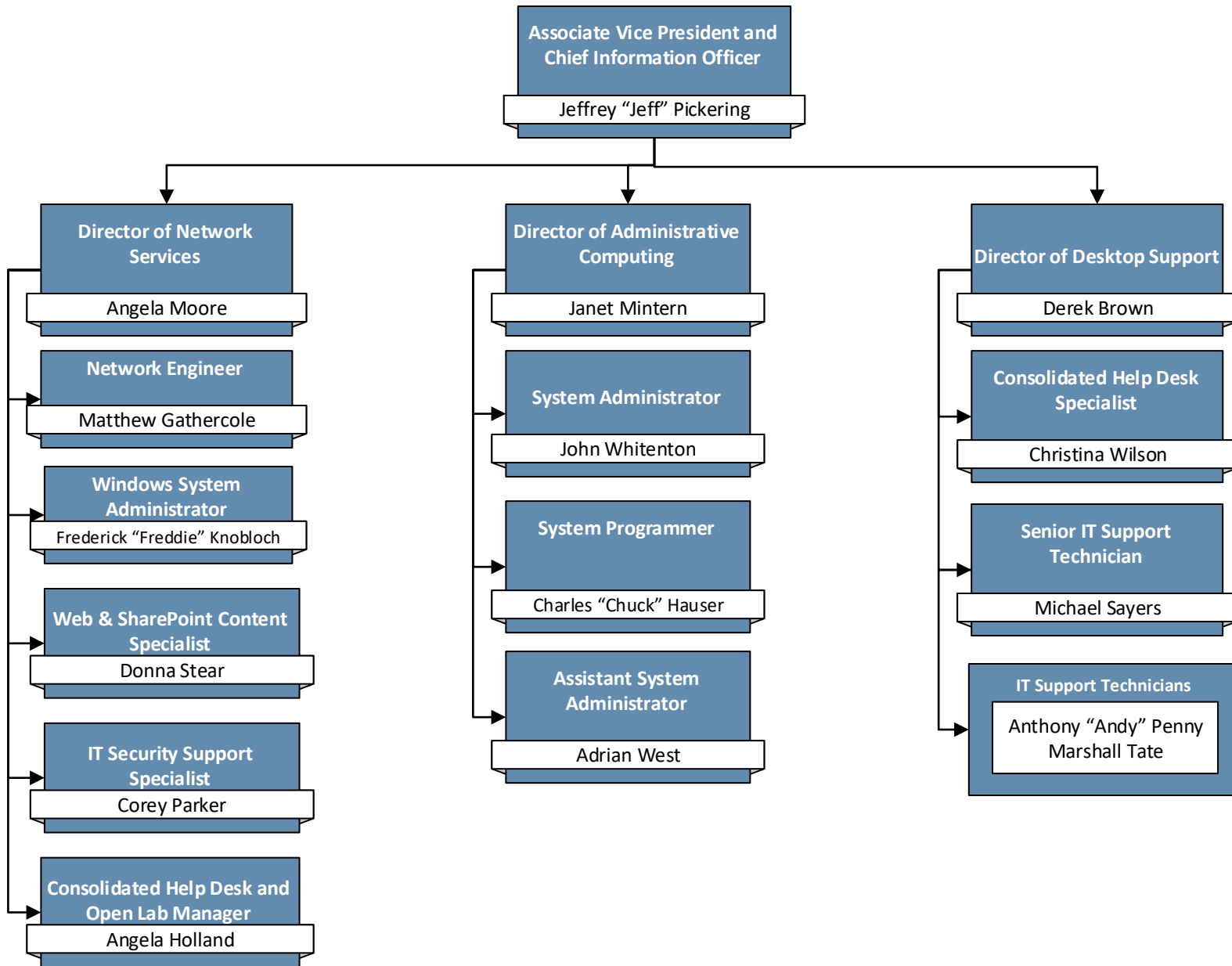



# Organizational Structure

## Instruction

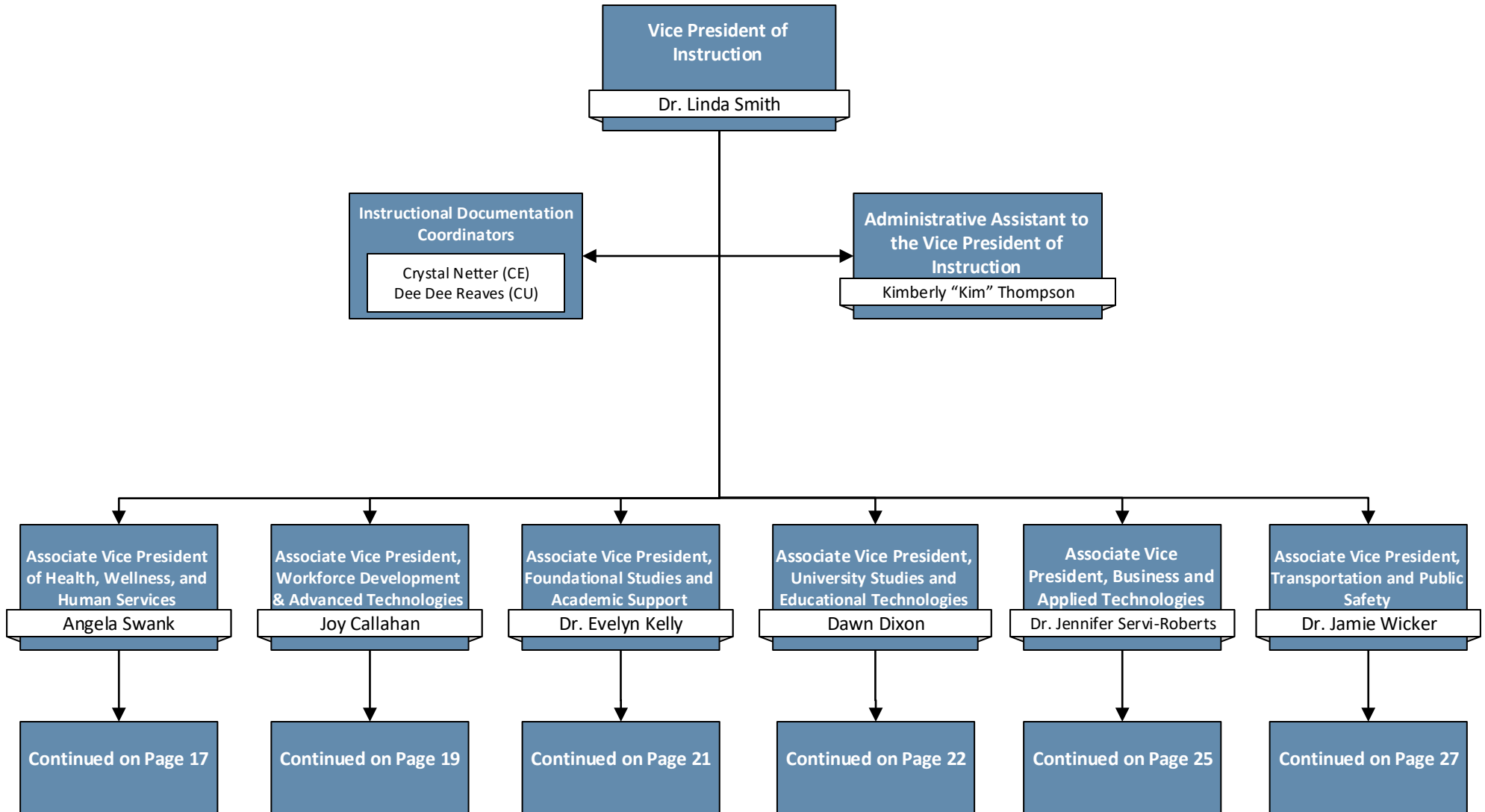





# Organizational Structure

## Health, Wellness, and Human Services

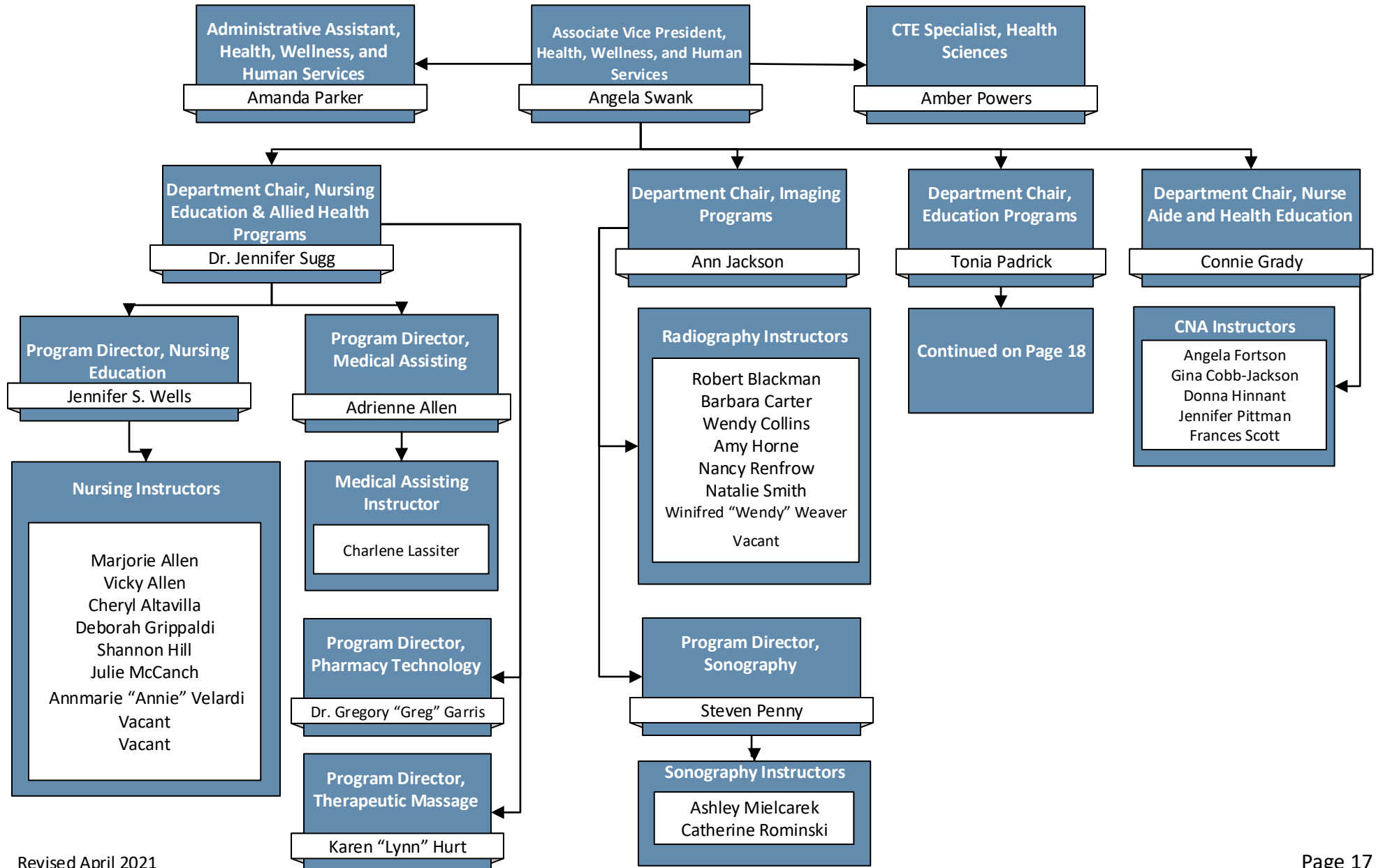



# Organizational Structure

## Education Programs

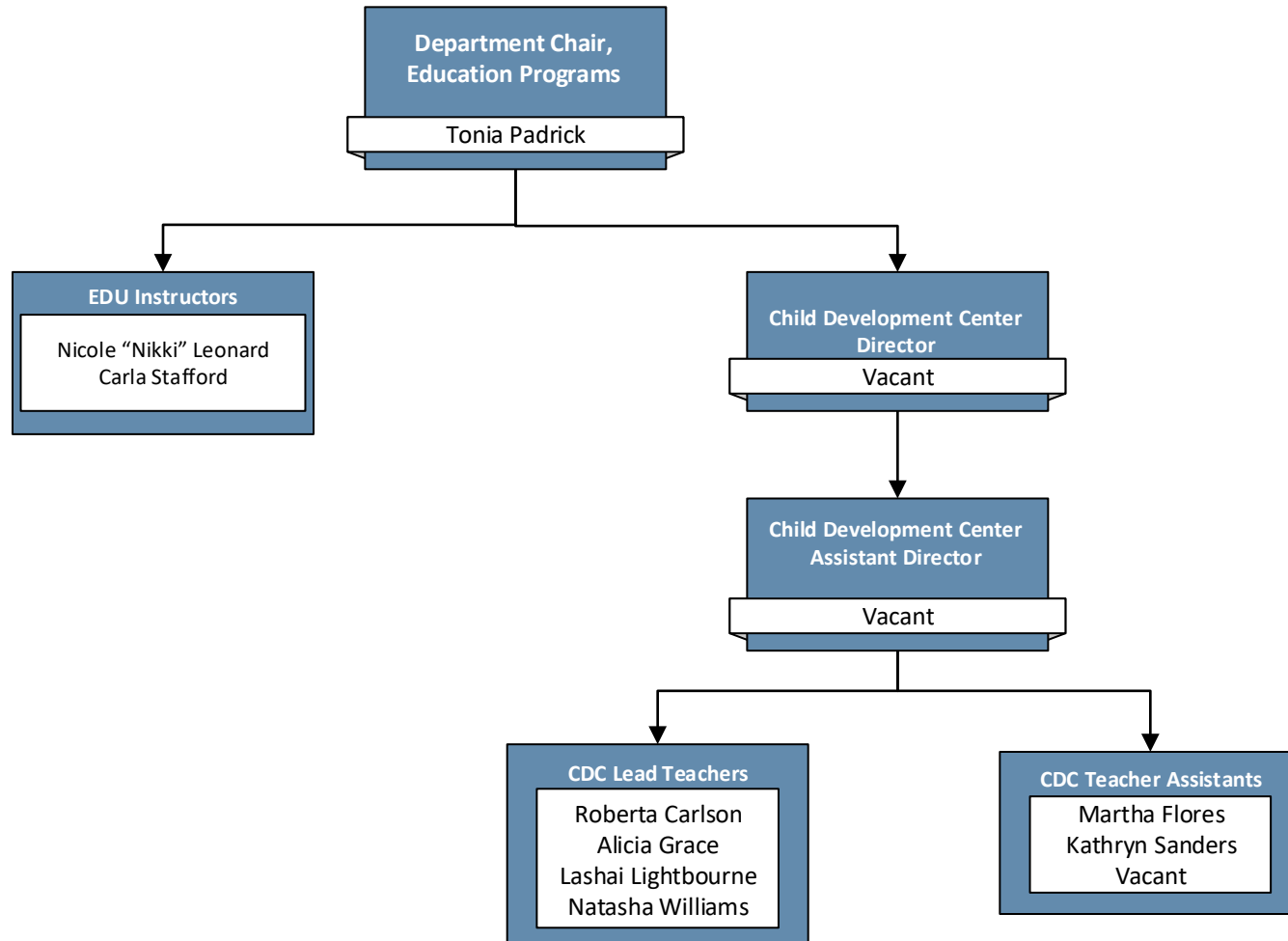



# Organizational Structure

## Workforce Development and Advanced Technologies

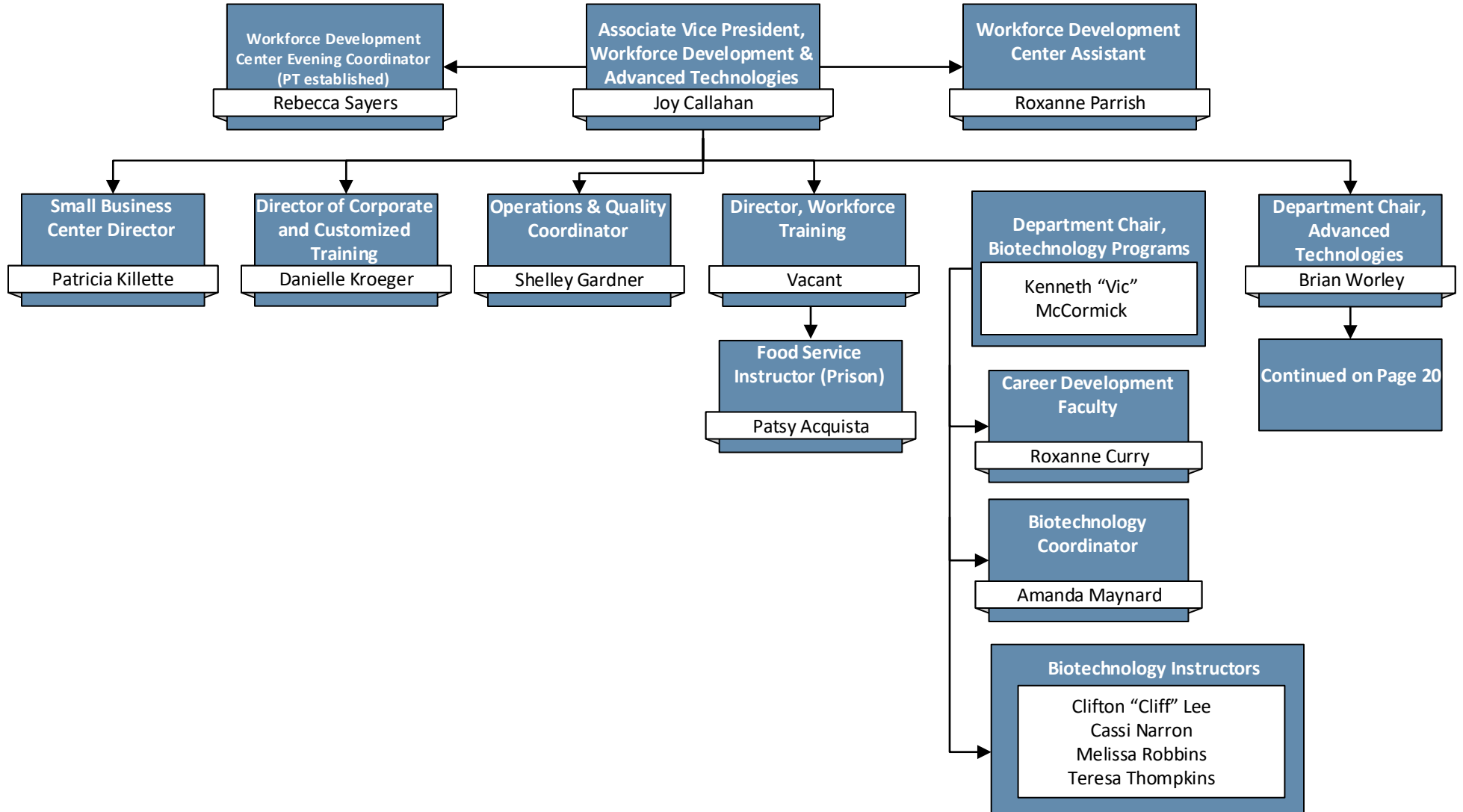

Continued on Page 20



# Organizational Structure

## Advanced Technologies

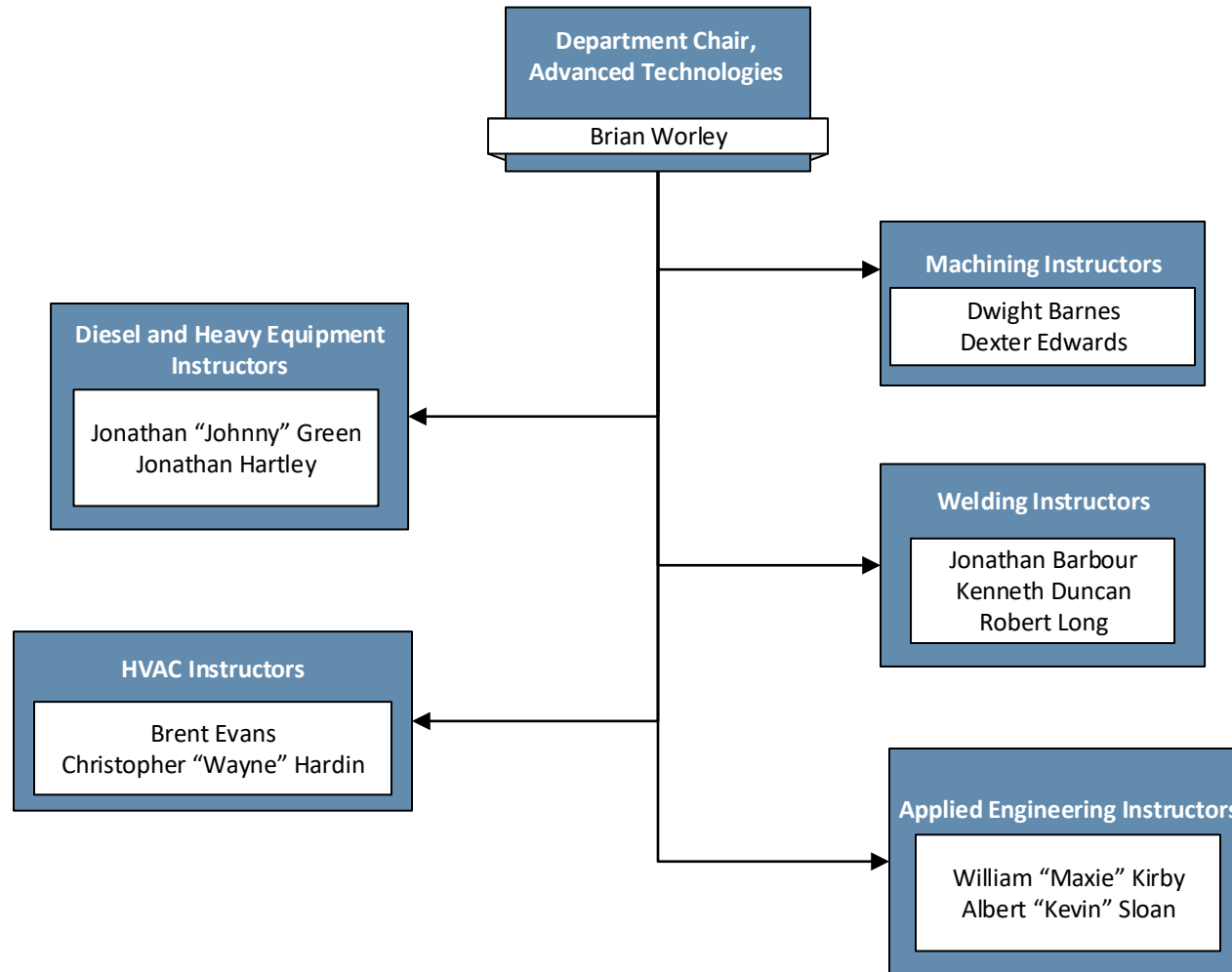



# Organizational Structure

## Foundational Studies and Academic Support

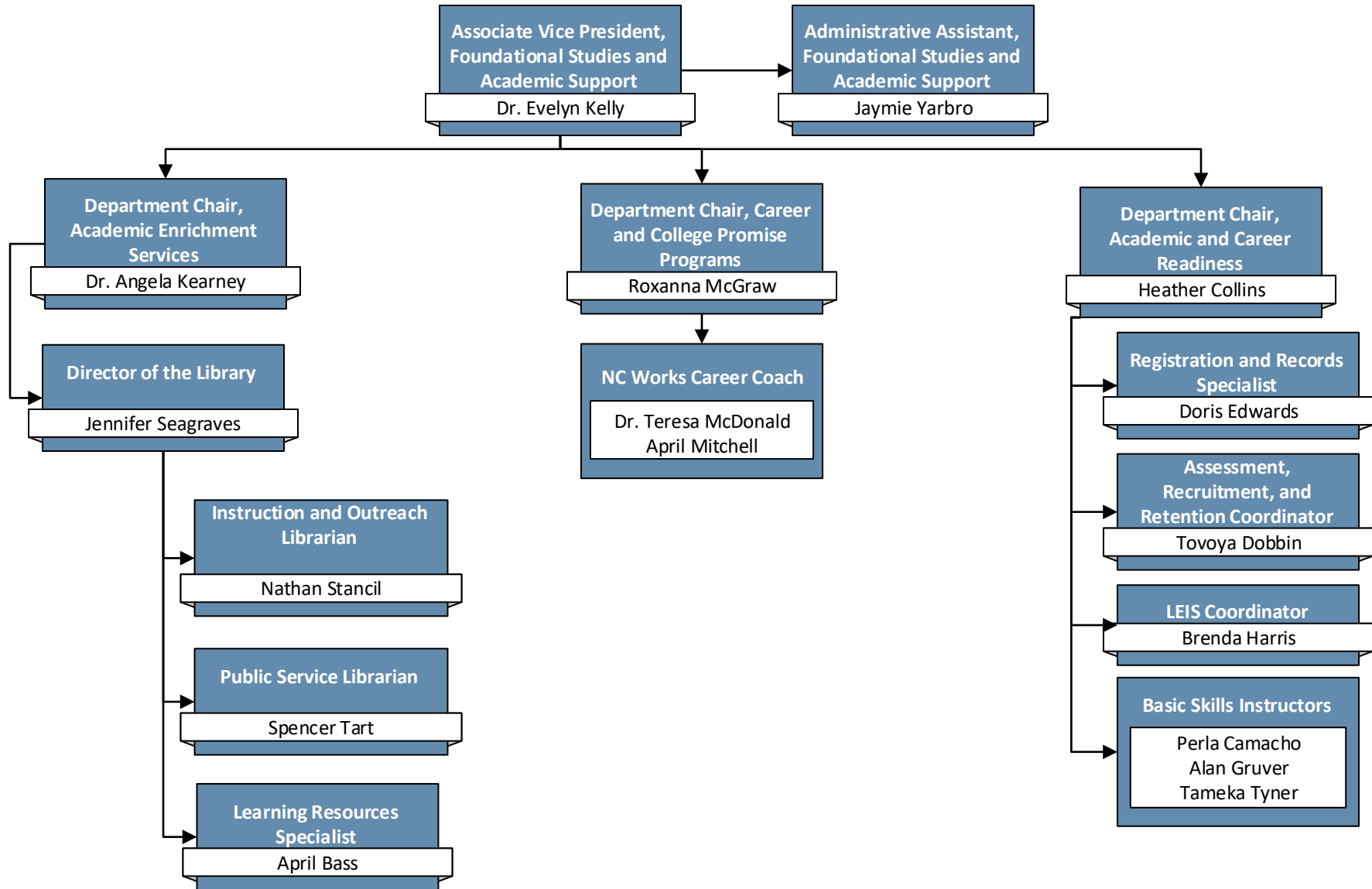



# Organizational Structure

## University Studies and Educational Technologies

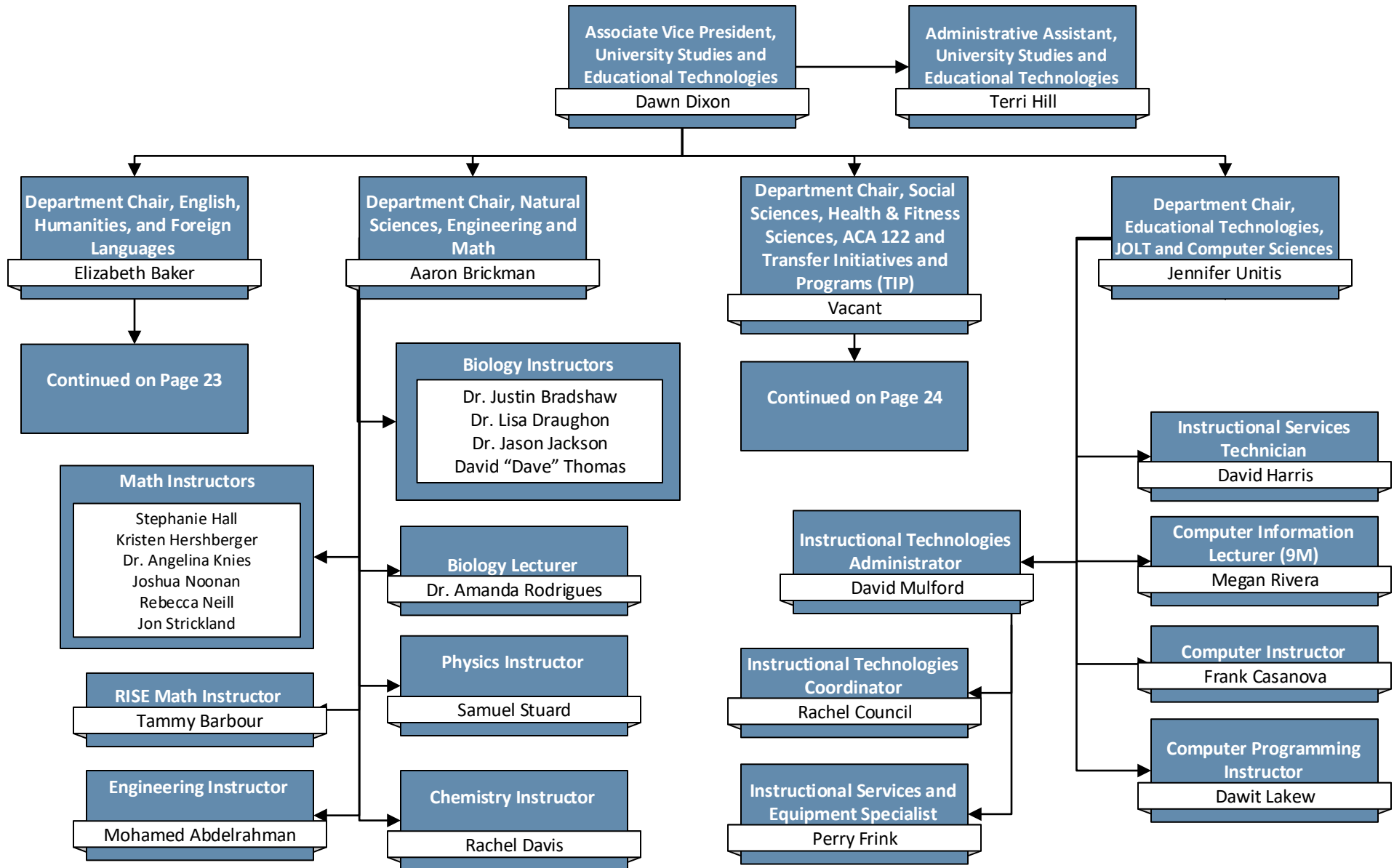



# Organizational Structure

## English, Humanities, and Foreign Languages

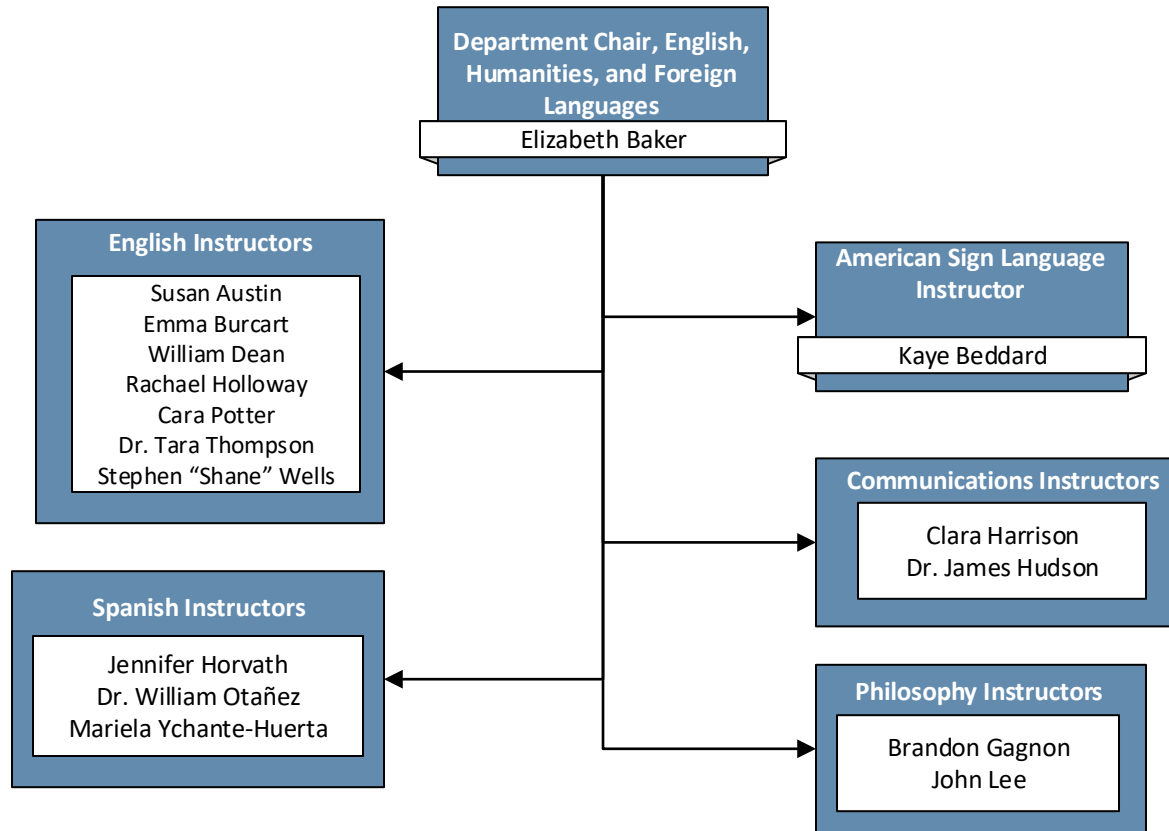



# Organizational Structure

Social Science, Health & Fitness, ACA 122 & TIP

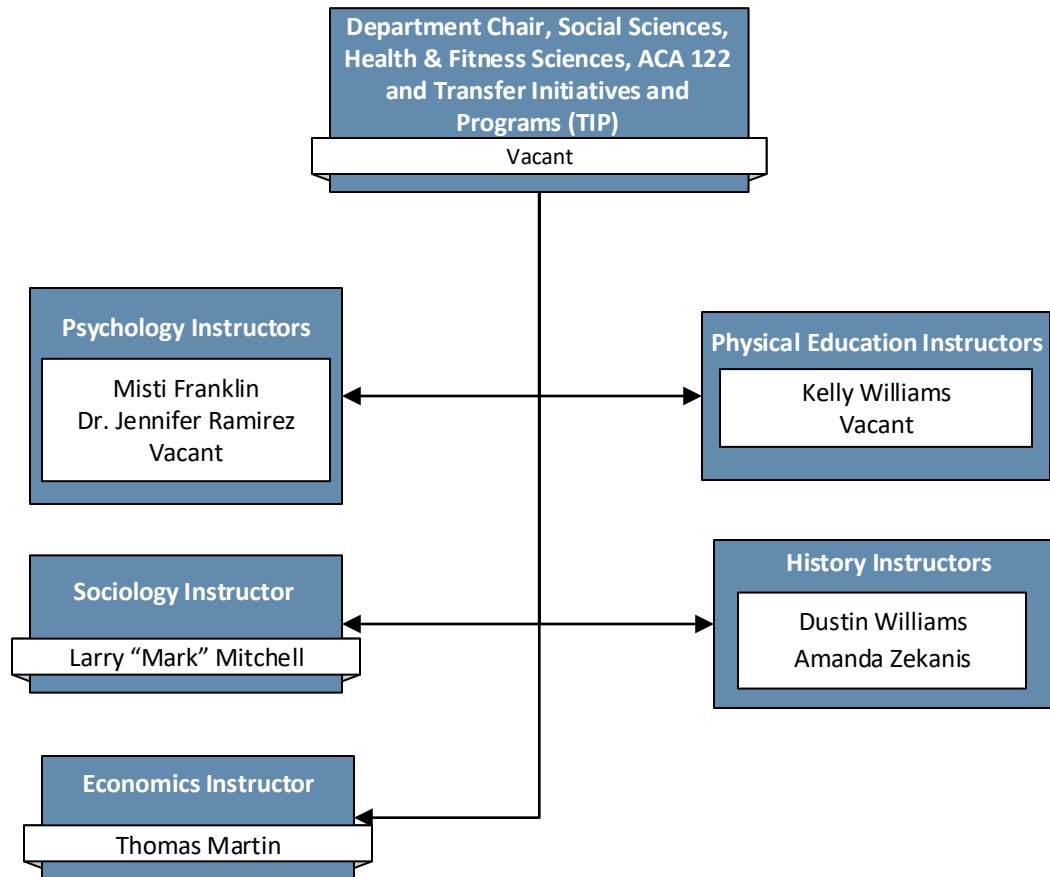





# Organizational Structure

## Business and Applied Technologies

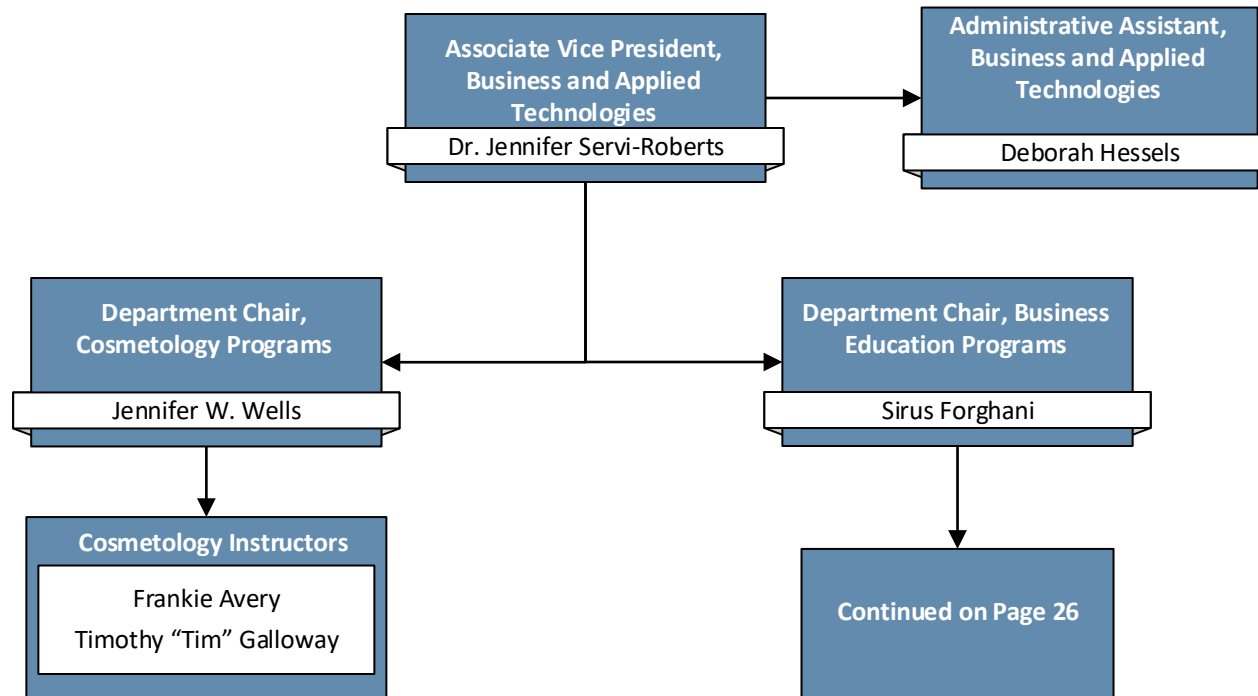



# Organizational Structure

## Business Education Programs

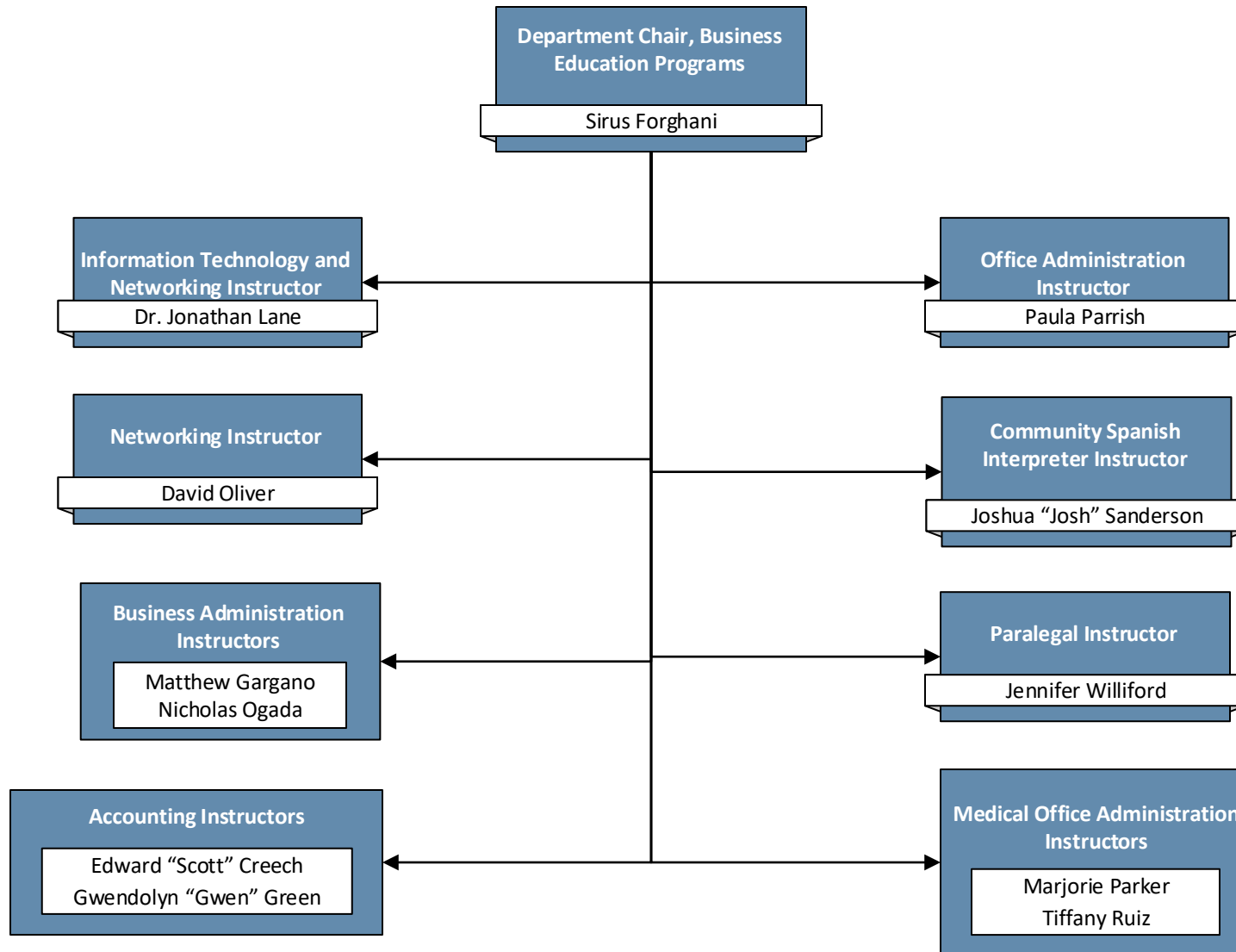



# Organizational Structure

## Transportation and Public Safety

